

RKE-M - without power transmitter

APPLICATION

Particularly suitable for use on machining centers and palletisers.

TYPE

Clamping system mechanical without power transmitter, manually operated.

CUSTOMER BENEFITS

- ③ Horizontal, side or in connection with a base plate vertical mounting, for example as DUO clamping tower (back to back)
- ③ Sturdy chip protection prevents chips from penetrating
- ③ Large clamping stroke
- ③ Clamping surface for clamping claws
- ③ Central lubrication of guides and spindle thread
- ③ Constant clamping force for every clamping operation and high clamping repeatability when a torque wrench is used

TECHNICAL FEATURES

- Sturdy steel body and all guides are hardened and ground on all sides
- Long clamping slide with cross slots, hardened on all sides, functional surfaces ground
- Threaded bores for taking up all RÖHM flat clamping jaws with jaw width 125/160 mm

RKE-M = RÖHM, compact, single clamping, manual

A32

RKE-M, with stepped jaws

Item no.	182137	182138	182139	182140 ▲
Jaw width A mm	92	125	160	200
Jaw design	stepped jaws	stepped jaws	stepped jaws	stepped jaws
B2 mm	0-138	0 - 216	0 - 320	0 - 315
B3 mm	71-208	97 - 312	131 - 451	131 - 451
C mm	32	40	50	60
D mm	315	442	607	607
E mm	112	140	165	175
F mm	276	400	530	530
G _{±0,02} mm	80	100	115	115
H2 mm	80	112,5	130	135
H3 mm	41	56,5	64	64
J2 mm	56	70	97	97
K mm	94	126	162	162
L2 mm	64	94	98	103
M mm	25	40	34	39
M* mm	25	30	32,5	32,5
N _{±0,01} mm	16	20	25	25
Q	39	50,5	59,5	59,5
U mm	20	20	20	20
V mm	12	12	12	12
W mm	68	1x108	2x102,5	2x102,5
X mm	15	15	15	15
Y mm	10	10	10	10
Z mm	70	109	117	117
a mm	63	80	100	125
b mm	13,6	15,6	19,6	24,6
c1	M 6x14	M 8x14	M 8x14	M 10x15
c2	M 5x9	M 5x10	M 5x9	M 5x10
c3	M 10x16	M 10x18	M 10x18	M 14x20
c4	M5	M5	M5	M5
d mm	48	60	80	110
e mm	8	12	12	12
f mm	14	18	20	25
g mm	70	95	125	125
h	20	25	17,5	17,5
i	40	45	80	80
Ø k	M10x18	M 12x22	M 16x25	M 16x25
l mm	140	240	200	200
m _{±0,02} mm	60	127,5	70	65
n _{±0,02} mm	99	183,5	136	136
o	48	60	88	110
p	6	6	6	12
y ^{±0,01} mm	40	47,5	57,5	57,5
z mm	72	100	135	135
Square AF	12	14	19	19
Ø X ^{±7}	10	10	10	10
Clamping force kN	25	40	60	60
Weight kg	15	41	79	85



RKE-M - without power transmitter



NC-Compact vices
RKE-M

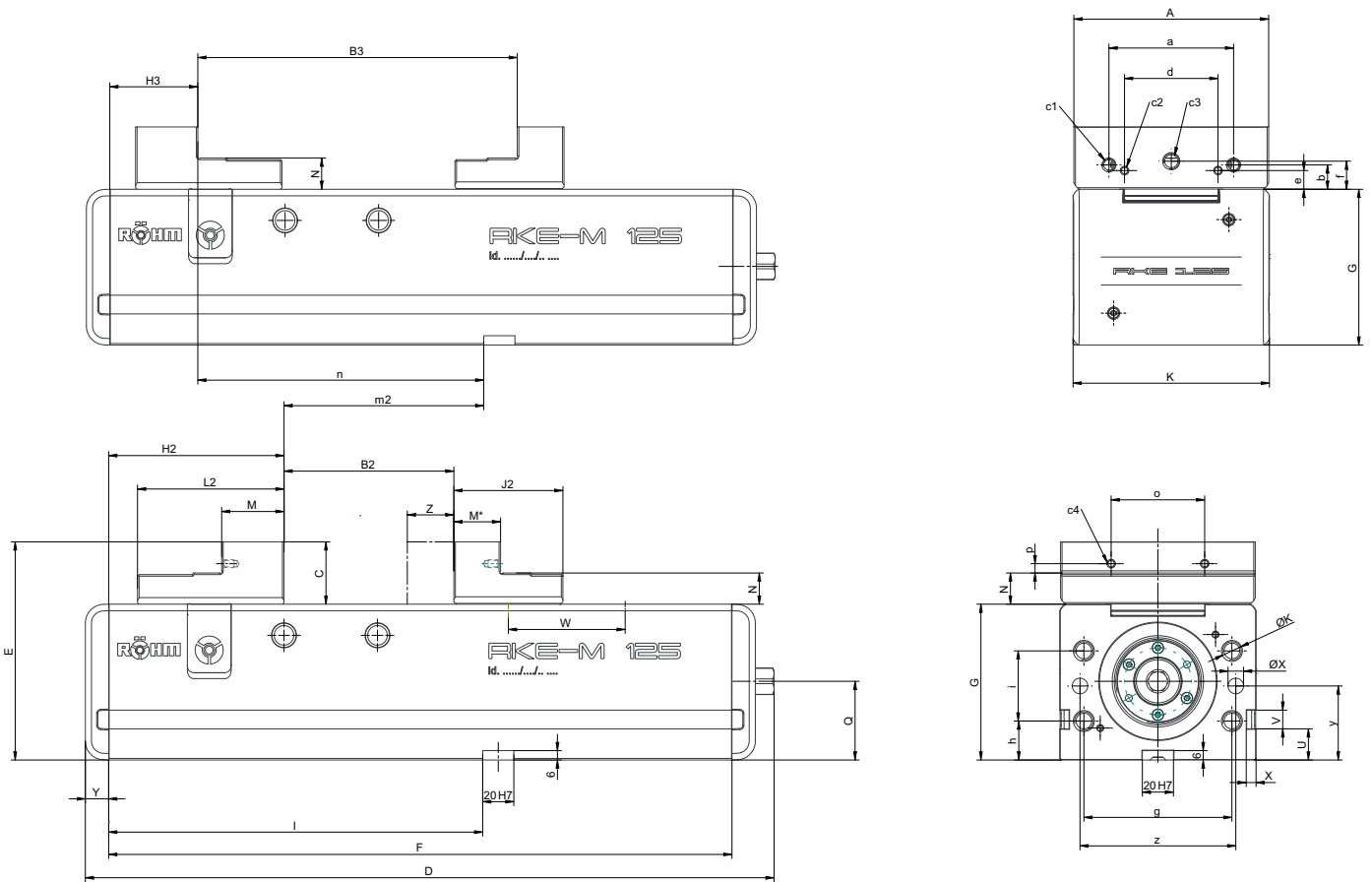

Accessories RKE-M

A37

Standard top jaws SA, reversible

Item no.	Contents of delivery	Size	Width mm	Height mm
162628 ▲	set	125	125	40
162629	set	160	160	50
162984	set	200	200	60



A37

Stepped jaws SB, reversible

Item no.	Contents of delivery	Size	Width mm	Height mm
178776	set	92	92	32
178230	set	125	125	40
178754	set	160	160	50
178937	set	200	200	60



A37

Double stepped jaws DSB, „smooth“

Item no.	Contents of delivery	Size	Width mm	Height mm
168698	set	92	50	48
175387 ▲	set	160	160	50
168693 ▲	set	125	62	60



A37

Carrier jaws TB, without swivelling claw inserts

Item no.	Contents of delivery	Size	Width mm	Height mm
165856	set	125	125	20
166218 ▲	set	160/200	160	25



A37

Carrier jaws, movable jaw pendular, without claw inserts

Item no.	Contents of delivery	Size	Width mm	Height mm
169383	set	92	115	20
165861	set	125	160	20
166223 ▲	set	160/200	200	25



A37

Swivelling claw inserts, for carrier jaws 743-72

Item no.	Contents of delivery	Size	Ø A mm	Ø J mm	Height mm
165854	piece	92/125	28	20	10
166216	piece	160/200	30	22	10



Accessories RKE-M

A37

Tensioner, for carrier jaws 743-72

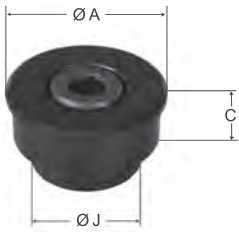

Item no.	Contents of delivery	Size	Ø A mm	Ø J mm	Height mm
169389	piece	92/125	28	20	10
169391	piece	160/200	30	22	10

A37

One-piece steel top jaws, for self-production of formed jaws or for clamping formed parts

Item no.	Contents of delivery	Size	Width mm	Height mm
160352	set	125	125	60
160353▲	set	160	160	70



A37

Normal jaw SGN, one side smooth, one side grooved, both sides ground



Item no.	Contents of delivery	Size	Width mm	Height mm
152752	piece	92	92	31,6
178112▲	piece	125	125	39,7
152755	piece	160	160	49,6
152759	piece	200	200	62,6

Including fixing screws

A37

Normal jaw finely checkered SGNf, reversible, to increase the specific contact pressure (higher holding forces), one side finely checkered, one side longitudinally grooved



Item no.	Contents of delivery	Size	Width mm	Height mm
163218▲	piece	92	92	31,6
180679▲	piece	125	125	39,7
156197	piece	160	160	49,6
156198	piece	200	200	62,6

Including fixing screws

A37

Claw jaws SKB with fine step, 2.5 mm clamping depth



Item no.	Contents of delivery	Size	Width mm	Height mm	Thickness mm
166514	set	92	92	32	14
166520	set	125	125	40	16
166522	set	160	160	50	18

Including fixing screws

Accessories RKE-M

A37
Claw jaws SKB without step, universal for clamping depth > 2.5 mm



Item no.	Contents of delivery	Size	Width mm	Height mm	Thickness mm
166661 ▲	set	92	92	32	14
166667	set	125	125	40	16
166669	set	160	160	50	18

Including fixing screws

A37
Support rails Cliparc, set with 10 different pairs of rails and 4 clamps in wooden box

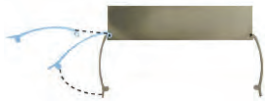

Item no.	Web height A	Jaw width B mm	Rail height H	Guiding width C	Spare clamp (Set = 4 pieces)
1269621 ▲	48	92	10/16/18/20/23/25/26/27/28/29	94	1269624
1269622	68	125	10/15/20/25/28/30/33/35/36/37	126	1269625
1269623	83	160	10/15/20/25/30/35/40/43/45/47	162	1269626

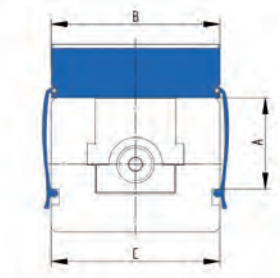
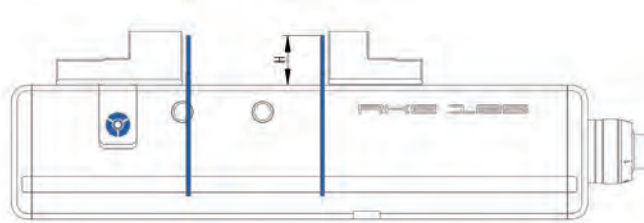

A37
V-jaw SPR, with vertically and horizontally ground-in prisms, hardened, for combination with SGN



Item no.	Contents of delivery	Size	Width mm	Height mm	Chucking capacity mm	
					Horizontal	Vertical
128770	piece	92	92	31,6	3-13	5-32
082363	piece	125	135	39,6	4-20	6-40
082364	piece	160	160	49,6	5-29	7-48
082365	piece	200	200	62,6	6-37	8-56

Including fixing screws

A37
Normal jaw SGNA, with movable workpiece stop, hardened and ground



Item no.	Contents of delivery	Size	Width mm	Height mm
150740 ▲	piece	125	135	39,6
150741 ▲	piece	160	160	49,6

Including fixing screws

A37
Draw-down jaws SNF, with spring plate, hardened and ground



Item no.	Contents of delivery	Size	Width mm	Height mm
077105 ▲	set	125	135	39,6
077106 ▲	set	160	160	49,6
077107 ▲	set	200	200	62,6

Including fixing screws

Accessories RKE-M

A37

V-jaw and standard jaw SBO, unhardened and burnished, with workpiece support

Item no.	Contents of delivery	Size	Width mm	Height mm	Step	Chuck capacity mm	
						Horizontal	Vertical
317259	set	92	110	31,8	3,5x3,3	3-12	5-32
317260	set	125	135	39,8	4x4,3	3-13	6-40
317261	set	160	160	49,8	4x4,8	5-22	7-48

Including fixing screws

A37

Draw-down jaws RNG, with two permanent magnets



Item no.	Contents of delivery	Size	Width mm	Height mm
155237 ▲	set	92	92	32
159227	set	125	125	39,5
155240	set	160	160	50
163782 ▲	set	200	200	60

Including fixing screws

A37

Standard insert RNS, held by two permanent magnets

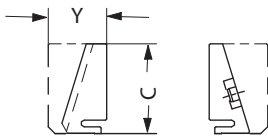

Item no.	Contents of delivery	Size	Width mm	C mm	Y mm
155242 ▲	set	92	92	32	21
159232	set	125	125	40	26
155245 ▲	set	160	160	50	30
163783	set	200	200	60	34



A37

Standard insert finely checkered RNSf, held by two permanent magnets

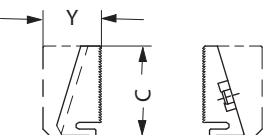

Item no.	Contents of delivery	Size	Width mm	C mm	Y mm
163270	set	92	92	32	21
163267 ▲	set	125	125	40	26
163273 ▲	set	160	160	50	30
163784 ▲	set	200	200	60	34



A37

Claw insert RNK, held by two permanent magnets

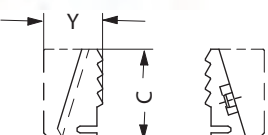
Item no.	Contents of delivery	Size	Width mm	C mm	Y mm
155247	set	92	92	32	21
159235 ▲	set	125	125	40	26
155250 ▲	set	160	160	50	30
163785 ▲	set	200	200	60	34



Accessories RKE-M

A37

Floating jaw horizontal PEB, for clamping non-parallel workpieces

Item no.	Contents of delivery	Size	Width mm	Height mm	Thickness mm
156190 ▲	piece	92	113	32	36
156191	piece	125	135	40	40
156192 ▲	piece	160	160	50	45
156193 ▲	piece	200	200	63	55

C15

Hand crank HKU, with octagon socket



Item no.	Contents of delivery	Size	Octagon	Key-width SW	L
009151 ▲	piece	92	12		100
009152	piece	125	14	Octagon	125
009154	piece	160/200	19	Octagon	200

A37

Single clamp SPE, for mounting vices on end and on the base

Item no.	Contents of delivery	T-slot	Thread
149121	piece	12	M10x50
149122	piece	14	M12x55
149123	piece	16	M12x60
149124	piece	18	M16x60
155722	piece	20	M16x65
151507	piece	22	M16x65

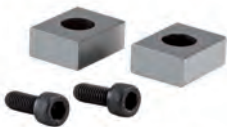
A37

Fixed slot nuts NTS, hardened and ground, with fixing screw

Item no.	Contents of delivery	Size	Length mm
014823	set	20x12	22
014825	set	20x14	25
014827	set	20x16	25
014829	set	20x18	25
014831	set	20x20	22
014833	set	20x22	32

A26

Torque wrench

Item no.	Torque Nm	Length mm	Output	Working accuracy
10004116	20-120	435	12,7=1/2"	3%
10004117	60-320	659	12,7=1/2"	3%

A37

Drive adapter ATA

Item no.	Contents of delivery	Size	Square
168721	piece	92	12-1/2"
161103	piece	125	14-1/2"
161730	piece	160/200	19-1/2"